

Electrical Connection Options

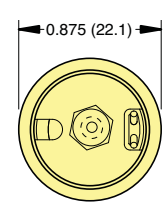

Valve Types

In-Line Mount

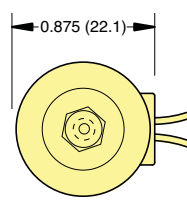
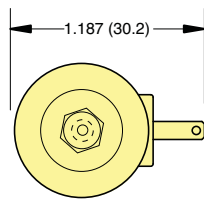
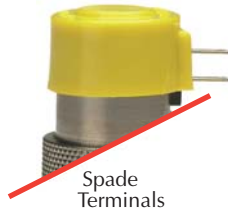
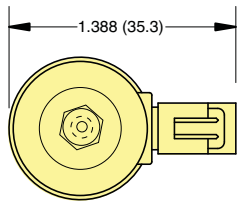
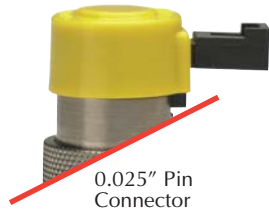
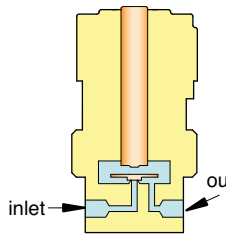

2-Way Normally-Closed In-Line Mount

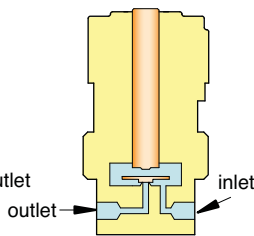

2-Way Normally-Closed High Flow In-Line Mount

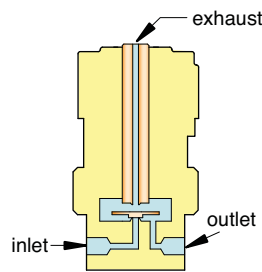

3-Way Normally-Closed In-Line Mount

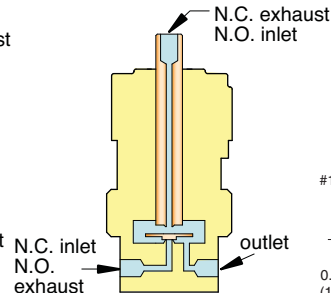

3-Way Fully-Ported In-Line Mount

Mounting Options

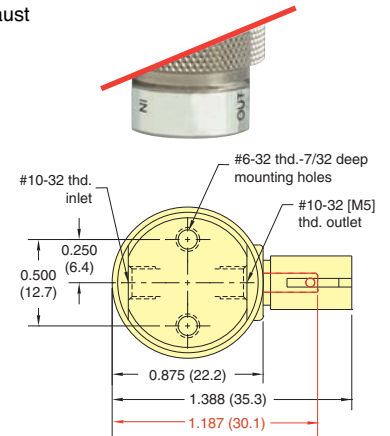

Manifold Mount

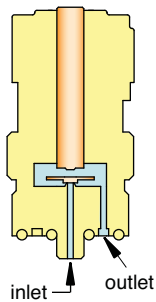

2-Way Normally-Closed Manifold Mount

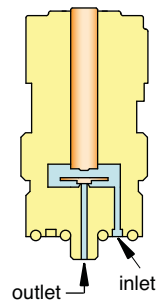

2-Way Normally-Closed High Flow Manifold Mount

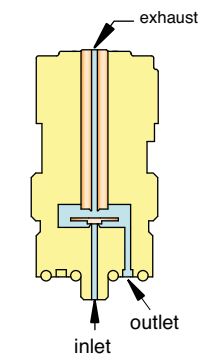

3-Way Normally-Closed Manifold Mount

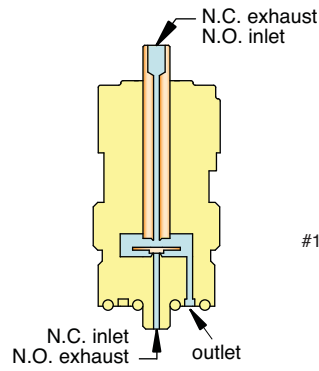

3-Way Fully-Ported Manifold Mount

